

# Catalogo Cordonatori

This document is Elitron's property. The data contained herein, in whole or in part, may not be duplicated, used or disclosed without written permission from Elitron.

## Legenda

### Tipologia

# 1:	Ø150mm	L 30mm
# 2:	Ø100	L 20mm
# 3:	15<Ø>28	L 10mm
# 4:	Ø<15	L 6mm

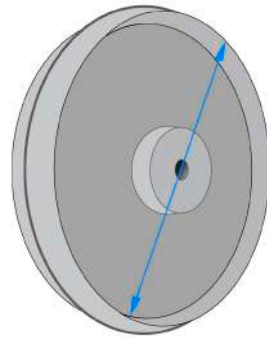

Diametro Ø

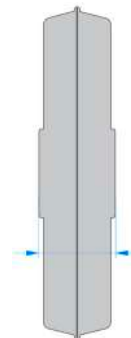

Larghezza "L"

### Caratteristiche

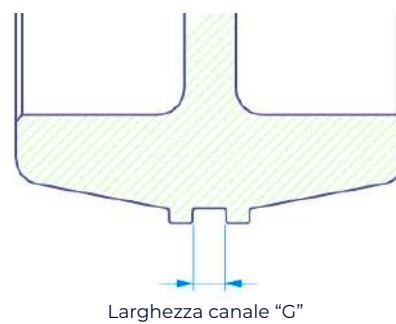
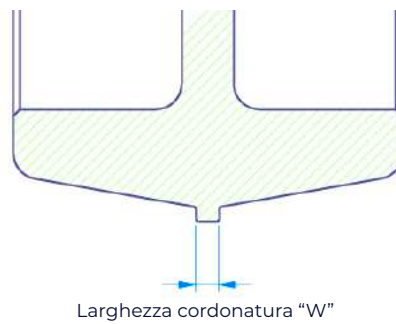
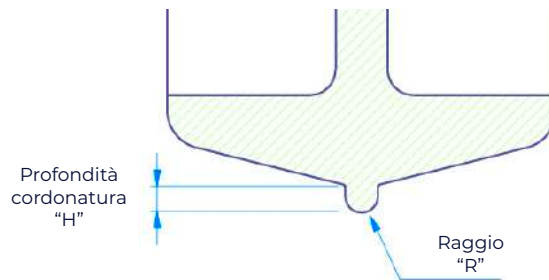



## 800458

Diametro Ø (mm): 150

Larghezza L (mm): 30

Raggio R (mm): 1,25

Larghezza cordonatura W (mm): 2,5

Profondità cordonatura H (mm): 1,9

Larghezza canale G (mm): -

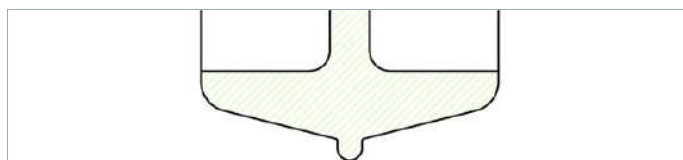

Materiali: cartone ondulato >4,5 mm  
Sistemi compatibili:

**KOMBO TAV**



## 800459

Diametro Ø (mm): 150

Larghezza L (mm): 30

Raggio R (mm): 0,9

Larghezza cordonatura W (mm): 1,8

Profondità cordonatura H (mm): 1,3

Larghezza canale G (mm): -

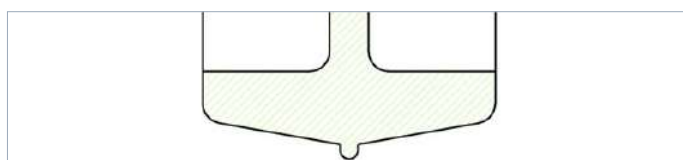

Materiali: cartone ondulato >4,5 mm  
Sistemi compatibili:

**KOMBO TAV**



## 800460

Diametro Ø (mm): 150

Larghezza L (mm): 30

Raggio R (mm): 2,5

Larghezza cordonatura W (mm): 5

Profondità cordonatura H (mm): 3,5

Larghezza canale G (mm): -

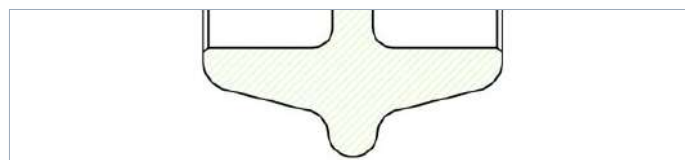

Materiali: cartone ondulato >4,5 mm  
Sistemi compatibili:

**KOMBO TAV**



## 800464

Diametro Ø (mm): 150

Larghezza L (mm): 30

Raggio R (mm): 2,7

Larghezza cordonatura W (mm): 1,8

Profondità cordonatura H (mm): 1,3

Larghezza canale G (mm): -

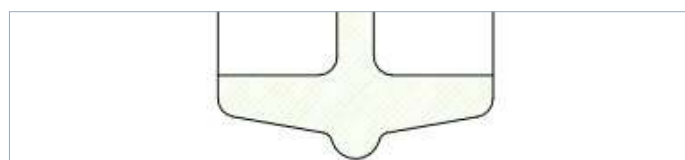

Materiali: cartone ondulato <4,5 mm  
Sistemi compatibili:

**KOMBO TAV**



## 800465

Diametro Ø (mm): 150

Larghezza L (mm): 30

Raggio R (mm): -

Larghezza cordonatura W (mm): 1,8

Profondità cordonatura H (mm): 1

Larghezza canale G (mm): 1,8

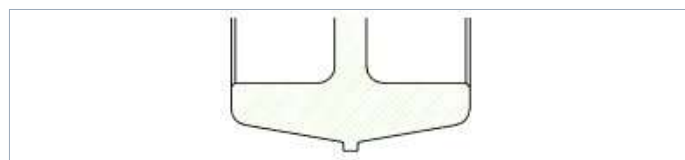

Materiali: cartone ondulato >4,5 mm  
Sistemi compatibili:

**KOMBO TAV**



## 800466

Diametro Ø (mm): 150

Larghezza L (mm): 30

Raggio R (mm): -

Larghezza cordonatura W (mm): 2

Profondità cordonatura H (mm): 0,5

Larghezza canale G (mm): -



Materiali: cartone ondulato >4,5 mm  
Sistemi compatibili:

**KOMBO TAV**



## 800289

Diametro Ø (mm): 100

Larghezza L (mm): 20

Raggio R (mm): 1

Larghezza cordonatura W (mm): 3,5

Profondità cordonatura H (mm): 2

Larghezza canale G (mm): -

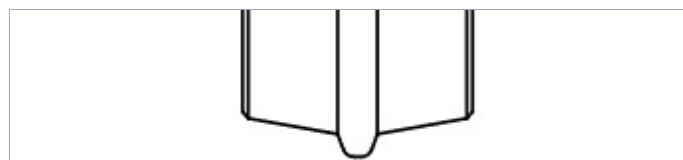

Materiali: cartone ondulato >4,5 mm  
Sistemi compatibili:

**KOMBO SD<sup>+</sup>**

**SPARK**



## 800474

Diametro Ø (mm): 100

Larghezza L (mm): 20

Raggio R (mm): 0,5

Larghezza cordonatura W (mm): 2,8

Profondità cordonatura H (mm): 5

Larghezza canale G (mm): -



Materiali: cartone ondulato >4,5 mm  
Sistemi compatibili:

**KOMBO SD<sup>+</sup>**

**SPARK**

## 800499



Diametro Ø (mm): 100

Larghezza L (mm): 20

Raggio R (mm): -

Larghezza cordonatura W (mm): 2

Profondità cordonatura H (mm): 0,6

Larghezza canale G (mm): -

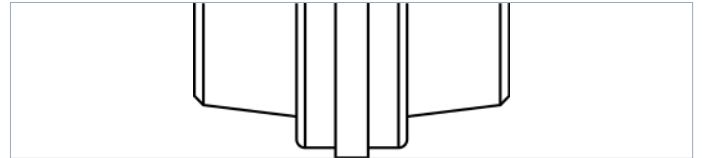

Materiali: **DISPA**  
Sistemi compatibili:

**KOMBO SD<sup>+</sup>**

**KOMBO TH**

**KOMBO SDC<sup>+</sup>**

**SPARK**

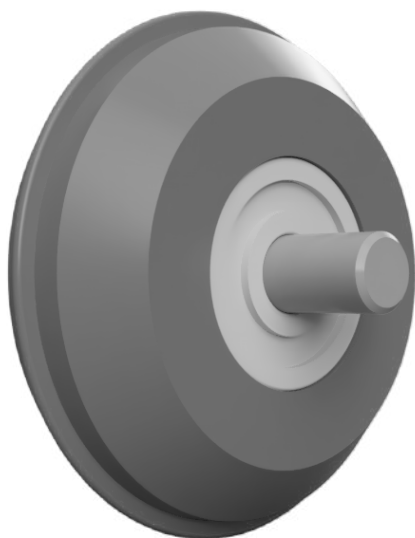

## 800290

Diametro Ø (mm): 28

Larghezza L (mm): 10

Raggio R (mm): 0,35

Larghezza cordonatura W (mm): 0,7

Profondità cordonatura H (mm): 1

Larghezza canale G (mm): -

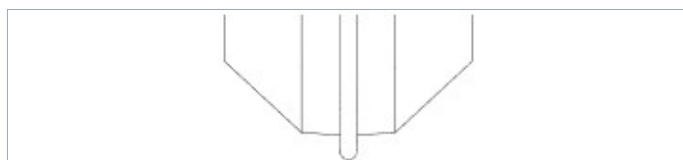

Materiali: cartoncino <300gr  
Sistemi compatibili:

**KOMBO SD<sup>+</sup>**

**SPARK**

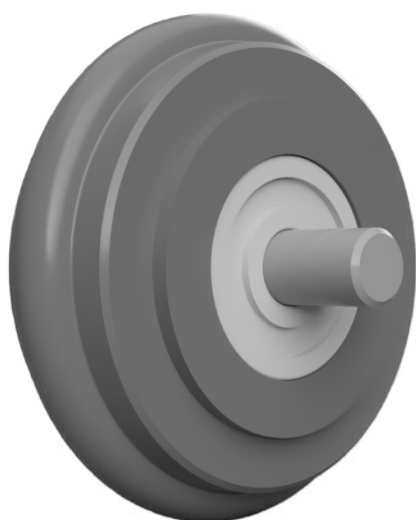

## 800292

Diametro Ø (mm): 28

Larghezza L (mm): 10

Raggio R (mm): 1,8

Larghezza cordonatura W (mm): 3,6

Profondità cordonatura H (mm): 1,7

Larghezza canale G (mm): -

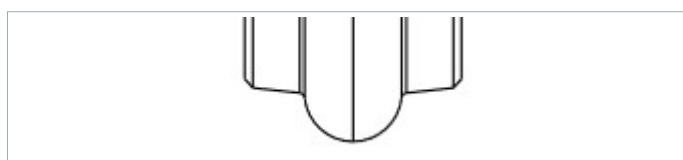

Materiali: cartone ondulato <4,5 mm  
Sistemi compatibili:

**KOMBO SD<sup>+</sup>**

**SPARK**



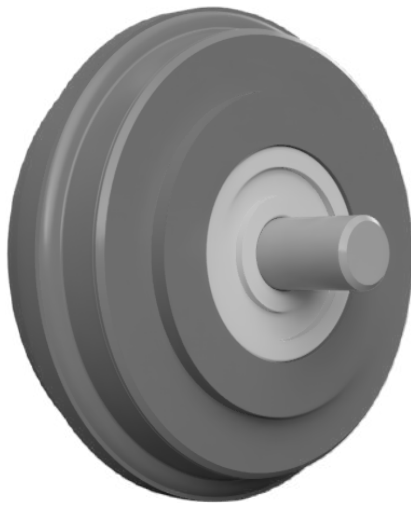

## 800300

Diametro Ø (mm): 28

Larghezza L (mm): 10

Raggio R (mm): 1,25

Larghezza cordonatura W (mm): 2,6

Profondità cordonatura H (mm): 1,2

Larghezza canale G (mm): -



Materiali: cartone ondulato <4,5 mm  
Sistemi compatibili:

**KOMBO TAV**

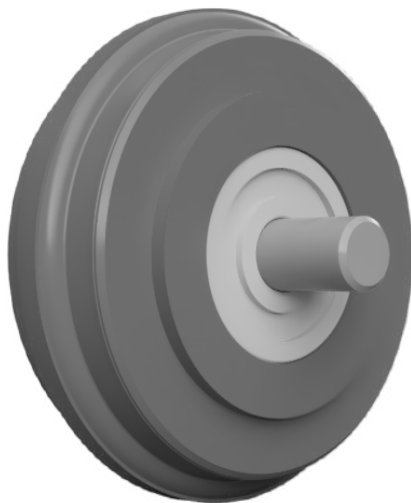

## 800461

Diametro Ø (mm): 28

Larghezza L (mm): 10

Raggio R (mm): 1,5

Larghezza cordonatura W (mm): 3

Profondità cordonatura H (mm): 1,3

Larghezza canale G (mm): -

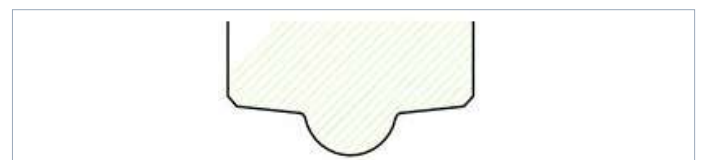

Materiali: cartone ondulato <4,5 mm  
Sistemi compatibili:

**KOMBO TAV**

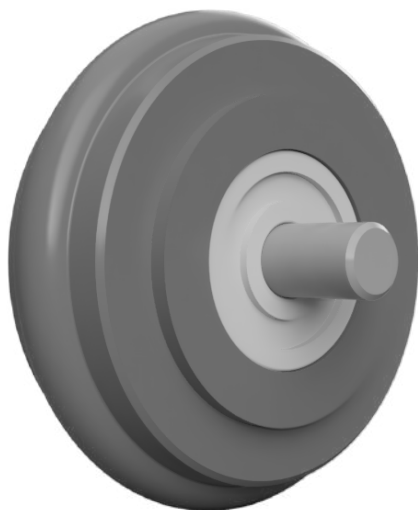

## 800462

Diametro Ø (mm): 28

Larghezza L (mm): 10

Raggio R (mm): 1,8

Larghezza cordonatura W (mm): 3,5

Profondità cordonatura H (mm): 1,5

Larghezza canale G (mm): -

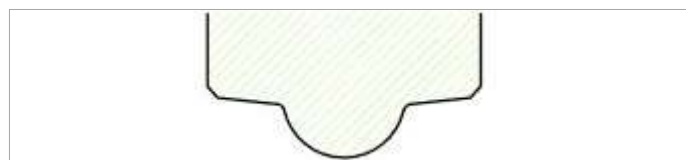

Materiali: cartone ondulato <4,5 mm  
Sistemi compatibili:

**KOMBO TAV**

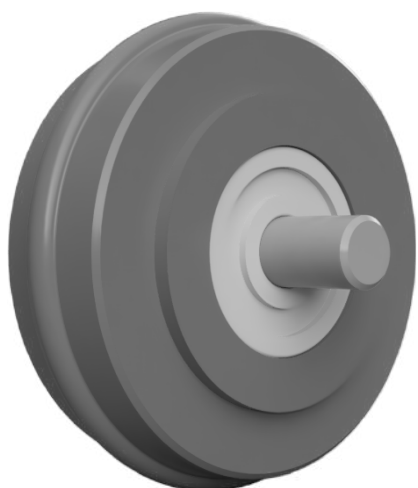

## 800463

Diametro Ø (mm): 28

Larghezza L (mm): 10

Raggio R (mm): 1

Larghezza cordonatura W (mm): 2

Profondità cordonatura H (mm): 0,8

Larghezza canale G (mm): -

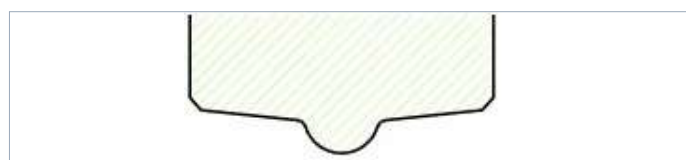

Materiali: cartone ondulato <4,5 mm  
Sistemi compatibili:

**KOMBO TAV**

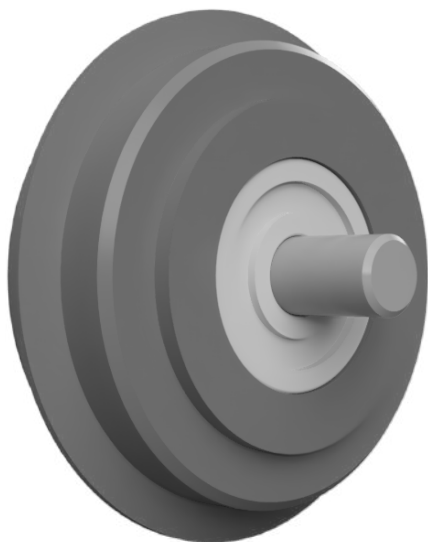

## 800467

Diametro Ø (mm): 28

Larghezza L (mm): 10

Raggio R (mm): -

Larghezza cordonatura W (mm): 0,5

Profondità cordonatura H (mm): 2

Larghezza canale G (mm): -

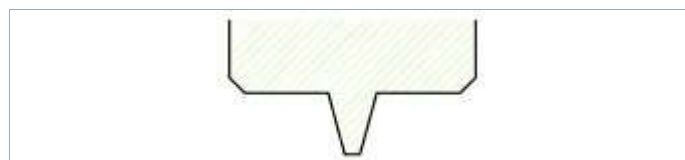

Materiali: policarbonato

Sistemi compatibili:

**KOMBO TAV**

**KOMBO SD<sup>+</sup>**

**SPARK**

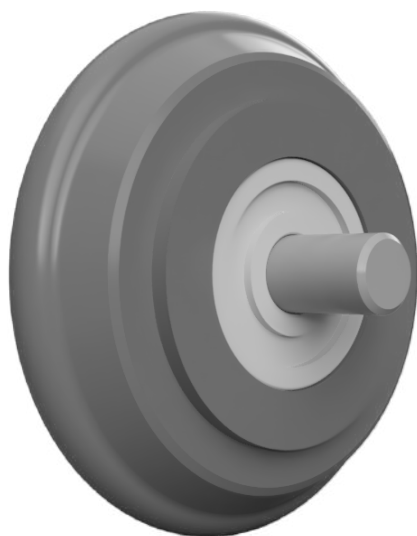

## 800473

Diametro Ø (mm): 28

Larghezza L (mm): 10

Raggio R (mm): 1,5

Larghezza cordonatura W (mm): 3,2

Profondità cordonatura H (mm): 1,2

Larghezza canale G (mm): -

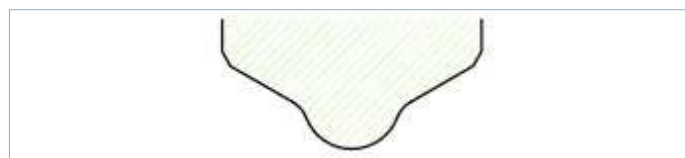

Materiali: cartone ondulato <4,5 mm

Sistemi compatibili:

**KOMBO TAV**

**KOMBO SD<sup>+</sup>**

**SPARK**

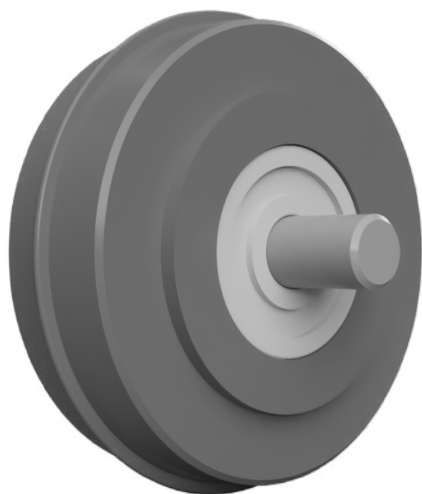

## 800478

Diametro Ø (mm): 28

Larghezza L (mm): 10

Raggio R (mm): 0,25

Larghezza cordonatura W (mm): 0,5

Profondità cordonatura H (mm): 0,7

Larghezza canale G (mm): -

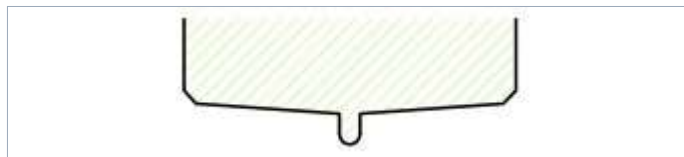

Materiali: cartoncino <300gr

Sistemi compatibili:

**KOMBO TAV**

**KOMBO SD<sup>+</sup>**

**SPARK**

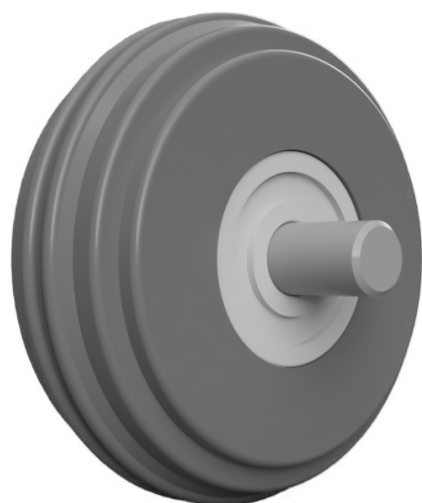

## 800479

Diametro Ø (mm): 28

Larghezza L (mm): 10

Raggio R (mm): 0,5

Larghezza cordonatura W (mm): 1,8

Profondità cordonatura H (mm): 1

Larghezza canale G (mm): 0,8

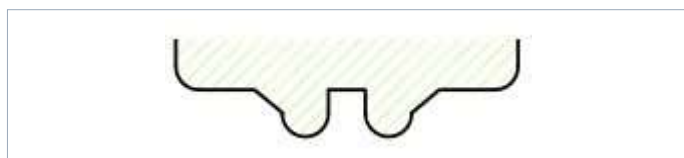

Materiali: cartoncino <300gr

Sistemi compatibili:

**KOMBO TAV**

**KOMBO SD<sup>+</sup>**

**SPARK**



## 800480

Diametro Ø (mm): 28

Larghezza L (mm): 10

Raggio R (mm): 0,5

Larghezza cordonatura W (mm): 2,2

Profondità cordonatura H (mm): 1

Larghezza canale G (mm): 1,2

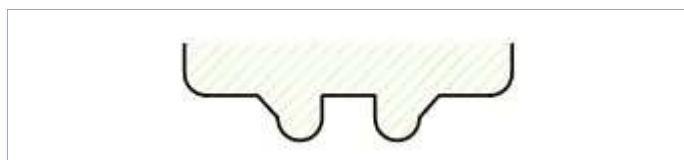

Materiali: cartoncino <300gr

Sistemi compatibili:

**KOMBO TAV**

**KOMBO SD<sup>+</sup>**

**SPARK**



## 800481

Diametro Ø (mm): 28

Larghezza L (mm): 10

Raggio R (mm): 0,5

Larghezza cordonatura W (mm): 2,6

Profondità cordonatura H (mm): 1

Larghezza canale G (mm): 1,6

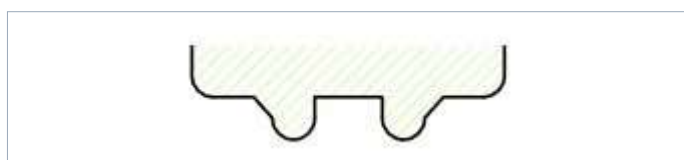

Materiali: cartoncino <300gr

Sistemi compatibili:

**KOMBO TAV**

**KOMBO SD<sup>+</sup>**

**SPARK**

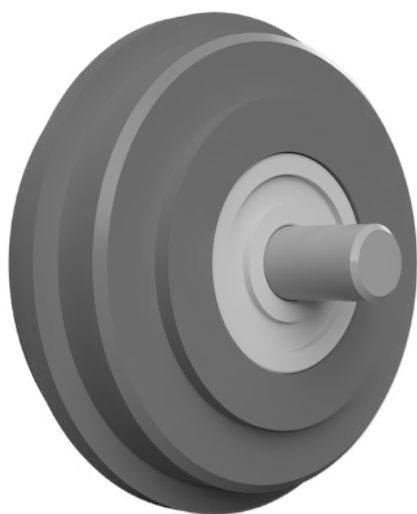

## 800483

Diametro Ø (mm): 28

Larghezza L (mm): 10

Raggio R (mm): -

Larghezza cordonatura W (mm): 1,5

Profondità cordonatura H (mm): 1,5

Larghezza canale G (mm): -

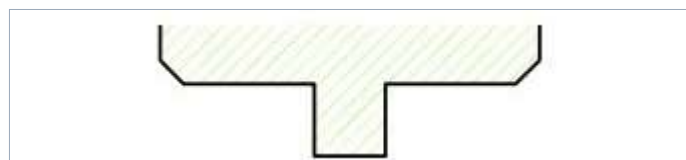

Materiali: cartoncino <300gr

Sistemi compatibili:

**KOMBO TAV**

**KOMBO SD<sup>+</sup>**

**SPARK**

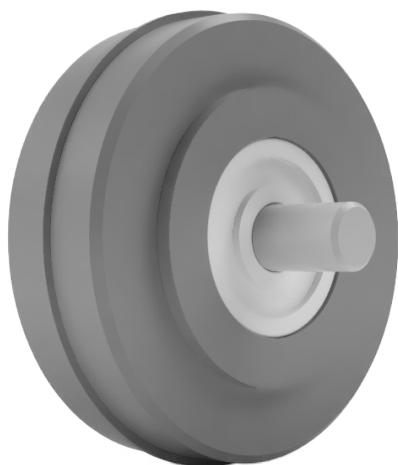

## 800493

Diametro Ø (mm): 28

Larghezza L (mm): 10

Raggio R (mm): -

Larghezza cordonatura W (mm): 0,5

Profondità cordonatura H (mm): 0,5

Larghezza canale G (mm): -

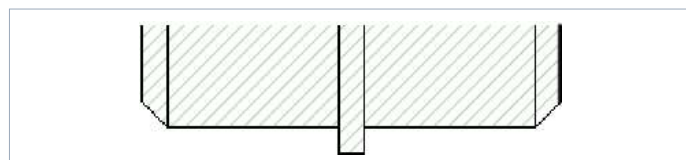

Materiali: cartoncino <300gr

Sistemi compatibili:

**KOMBO TAV**

**KOMBO SD<sup>+</sup>**

**SPARK**



## 800468

Diametro Ø (mm): 51

Larghezza L (mm): 10

Lunghezza taglio (mm): 10

Lunghezza cordonatura W (mm): 10

Profondità taglio (mm): 3



Sistemi compatibili:

**KOMBO TAV**



## 800469

Diametro Ø (mm): 51

Larghezza L (mm): 10

Lunghezza taglio (mm): 10

Lunghezza cordonatura W (mm): 10

Profondità taglio (mm): 6

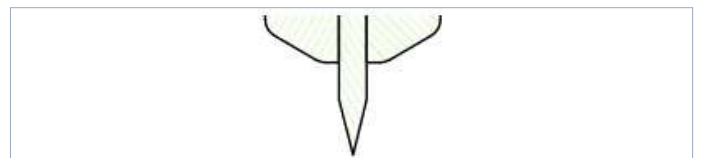

Sistemi compatibili:

**KOMBO TAV**





## 800470

Diametro Ø (mm): 51

Larghezza L (mm): 10

Lunghezza taglio (mm): 5

Lunghezza cordonatura W (mm): 5

Profondità taglio (mm): 4

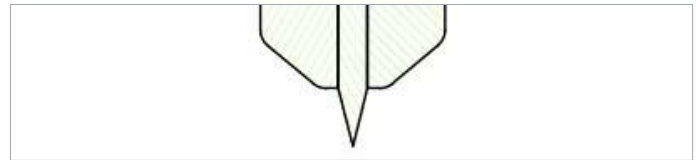

Sistemi compatibili:

**KOMBO TAV**



## 800471

Diametro Ø (mm): 51

Larghezza L (mm): 10

Lunghezza taglio (mm): 10

Lunghezza cordonatura W (mm): 4

Profondità taglio (mm): 5

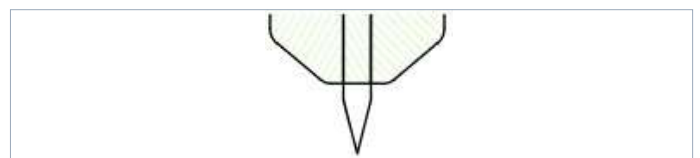

Sistemi compatibili:

**KOMBO TAV**





800472

Diametro Ø (mm): 51

Larghezza L (mm): 10

Lunghezza taglio (mm): 15

Lunghezza cordonatura W (mm): 27

Profondità taglio (mm): 8



Sistemi compatibili:

**KOMBO TAV**

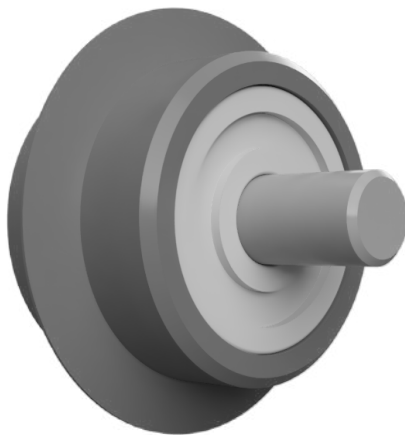

## 800291

Diametro Ø (mm): 20

Larghezza L (mm): 10

Raggio R (mm): -

Larghezza cordonatura W (mm): 0,2

Profondità cordonatura H (mm): 2,5

Larghezza canale G (mm): -

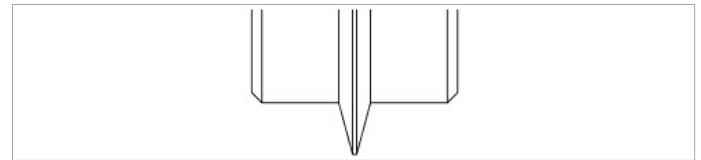

Materiali: policarbonato  
Sistemi compatibili:

**KOMBO SD<sup>+</sup>**

**SPARK**



## 800475

Diametro Ø (mm): 6,5

Larghezza L (mm): 6

Raggio R (mm): -

Larghezza cordonatura W (mm): 1

Profondità cordonatura H (mm): 1,7

Larghezza canale G (mm): -



Materiali: pelle  
Sistemi compatibili:

**KOMBO SD<sup>+</sup>**

**SPARK**



## 800476

Diametro Ø (mm): 15

Larghezza L (mm): 6

Raggio R (mm): -

Larghezza cordonatura W (mm): 3

Profondità cordonatura H (mm): 4,4

Larghezza canale G (mm): -



Materiali: pelle  
Sistemi compatibili:

**KOMBO SD<sup>+</sup>**

**SPARK**



## 800477

Diametro Ø (mm): 12

Larghezza L (mm): 6

Raggio R (mm): -

Larghezza cordonatura W (mm): 1,5

Profondità cordonatura H (mm): 2,9

Larghezza canale G (mm): -



Materiali: pelle  
Sistemi compatibili:

**KOMBO SD<sup>+</sup>**

**SPARK**



800482

Diametro Ø (mm): 58

Larghezza L (mm): 18

Raggio R (mm): -

Larghezza cordonatura W (mm): 2

Profondità cordonatura H (mm): 1,7

Larghezza canale G (mm): -



Materiali: cartone ondulato >4,5  
Sistemi compatibili:

**KOMBO EL**

Autor  
Composition and publication  
Copyright

Technical Marketing Department, Elitron  
Technical Marketing Department, Elitron  
Technical Marketing Department, Elitron

Version: 02  
Date: 04-2021  
Doc. no.: 20201100011IG

This document is Elitron's property. The data contained herein, in whole or in part, may not be duplicated, used or disclosed without written permission from Elitron.